

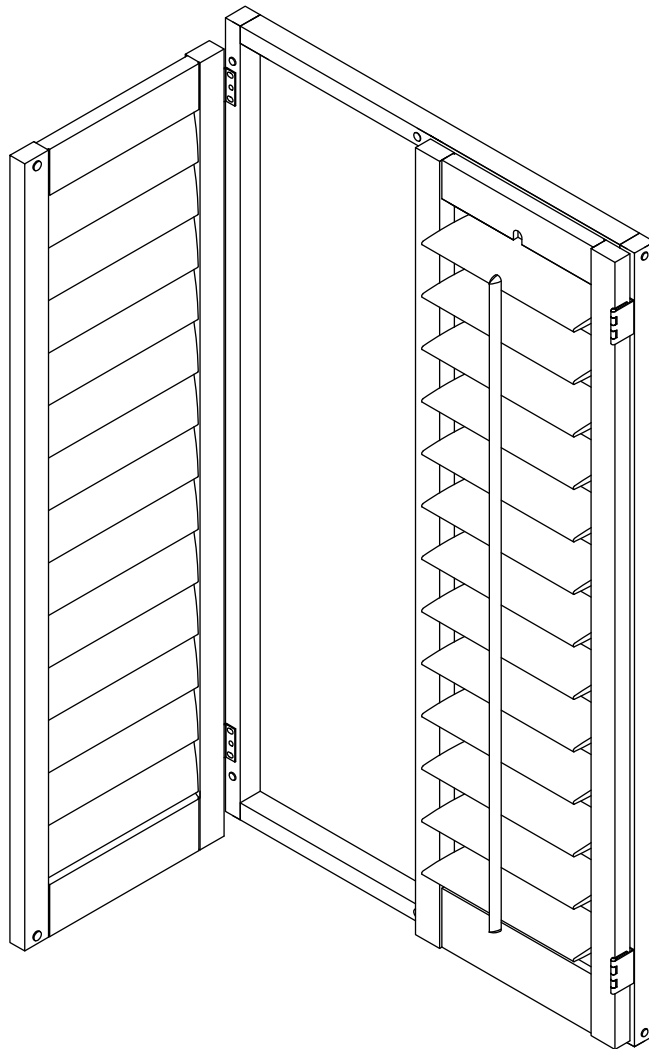

Design & Measuring Guide



KANDAS SHUTTERS

Jebel Ali Industrial area 1, Dubai, UAE, PO Box 62466

Ph: +971 48855711, Email: sales@kandasshutters.com

Choose Your Design

Kandas (moulded stiles)

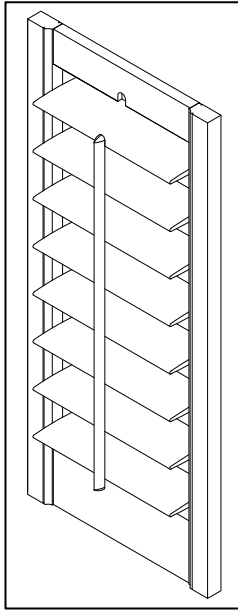

Tick Box

Kandas (flat stiles)

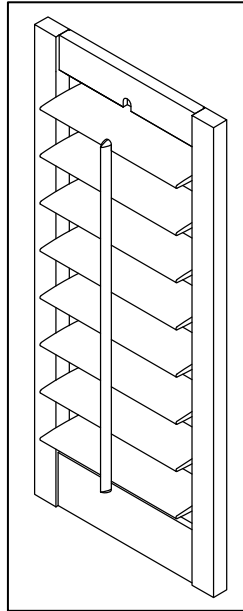

Tick Box

Manhattan

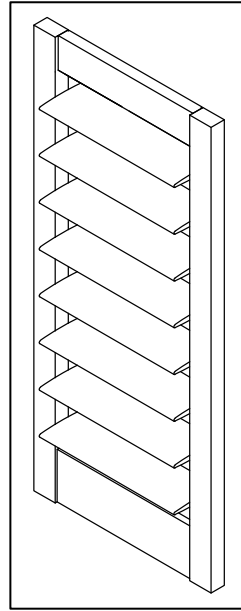

Tick Box

New York

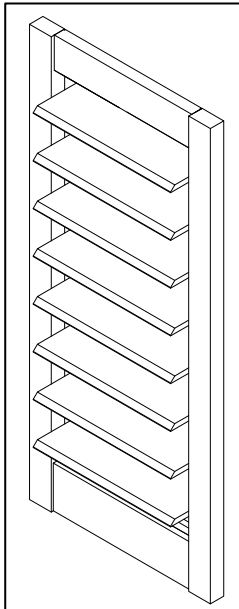

Tick Box

Highline

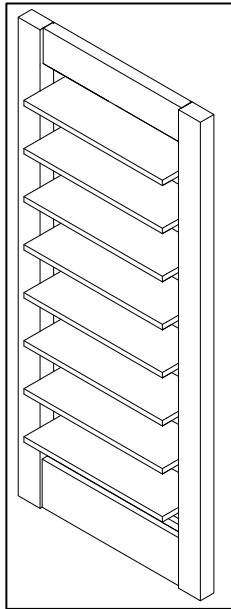

Tick Box

Soho

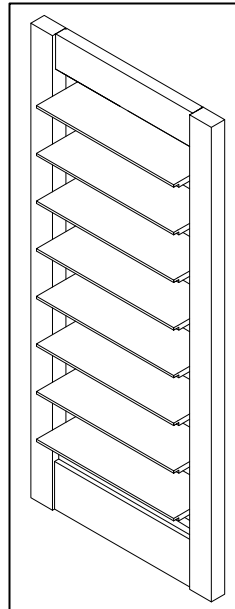

Tick Box

Solid

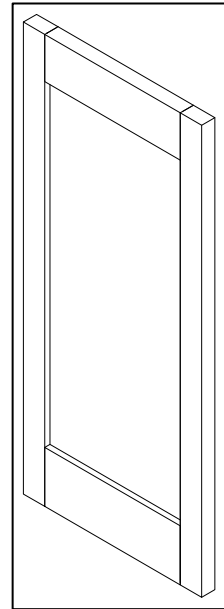

Tick Box

Choose Arrangement Style

Cafe style

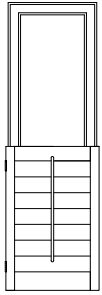

Tick Box

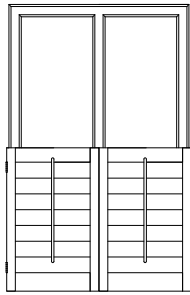

Tick Box

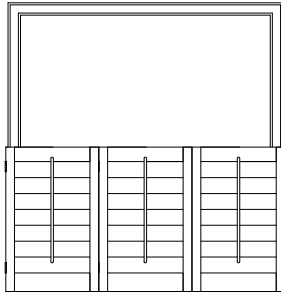

Tick Box

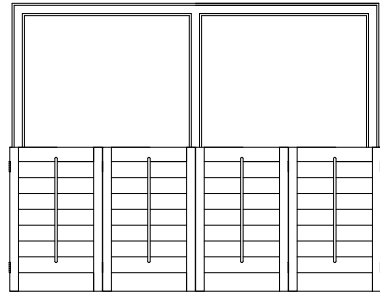

Tick Box

Full Height

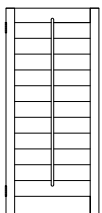

Tick Box

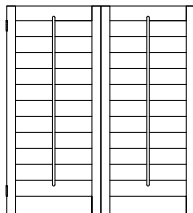

Tick Box

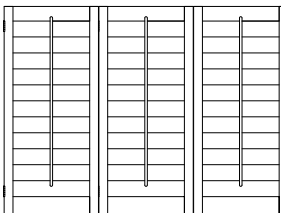

Tick Box

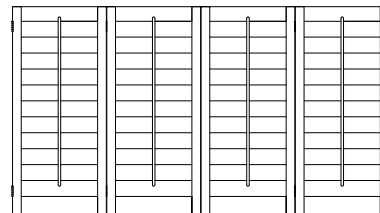

Tick Box

Full Height (with midrail)

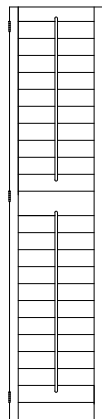

Tick Box

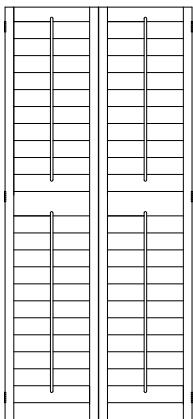

Tick Box

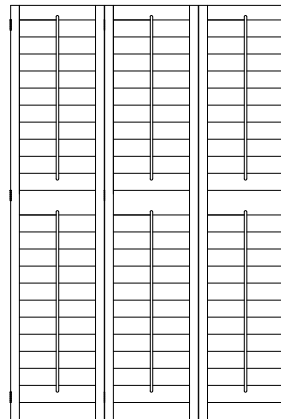

Tick Box

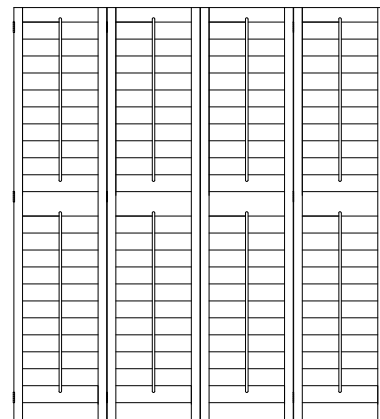

Tick Box

Tier-on-tier

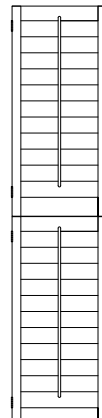

Tick Box

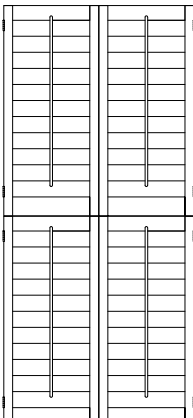

Tick Box

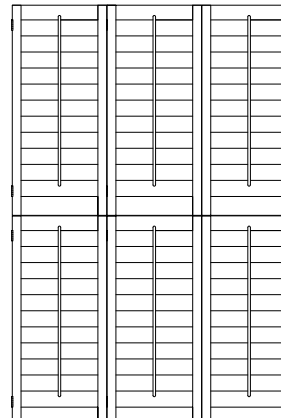

Tick Box

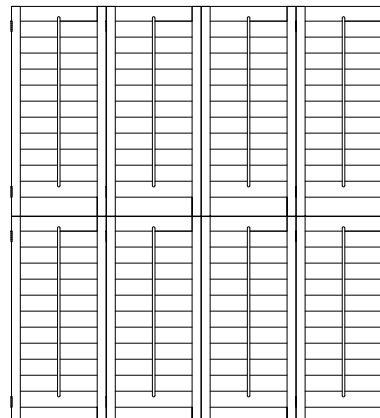

Tick Box



Choose Blade Size

Kandas & Manhattan

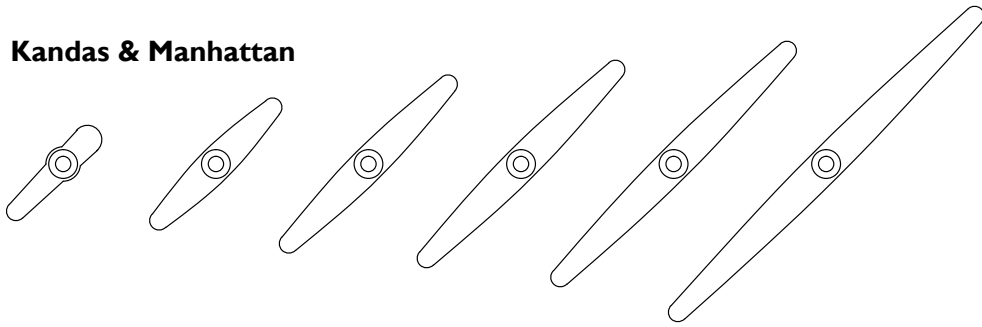

32mm



47mm



64mm



75mm



89mm



115mm



New York

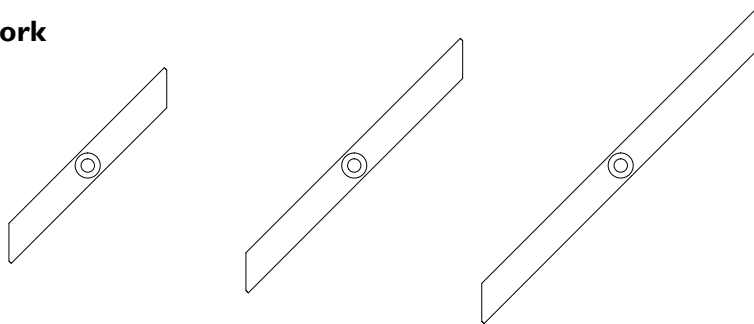

74mm



99mm



125mm



Highline

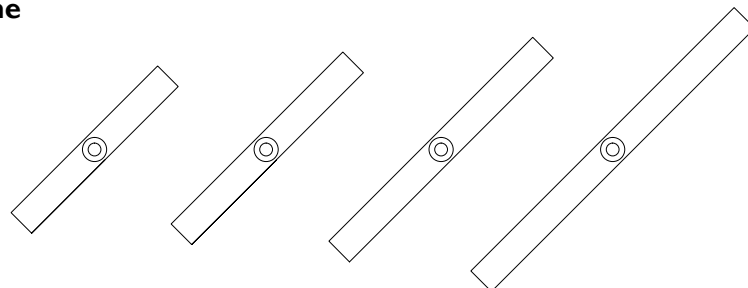

64mm



75mm



89mm



115mm



Soho

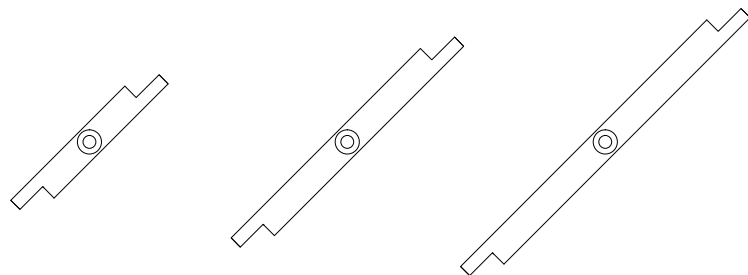

60mm



93mm



118mm



Choose Mounting Option

1. Battens within reveals

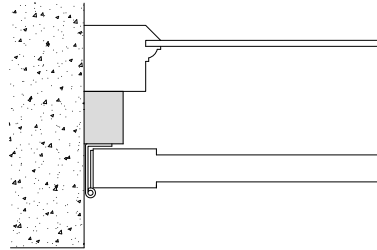
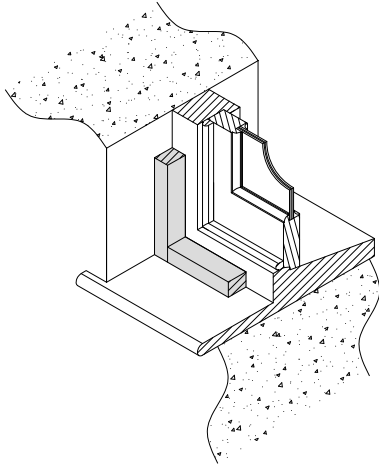

- Three sided Tick Box
- Four sided Tick Box

2. Battens on window face

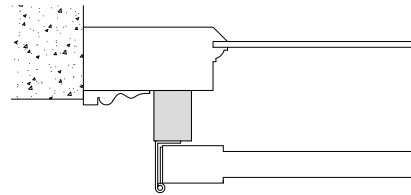
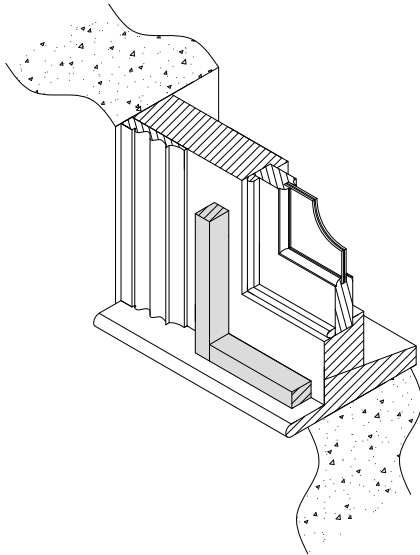

- Three sided Tick Box
- Four sided Tick Box

3. L Frame inside reveal – 4 sided

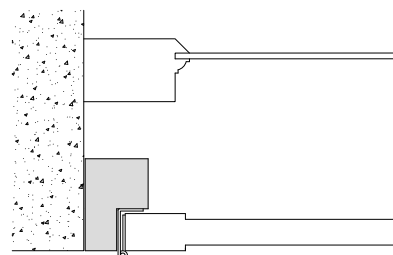
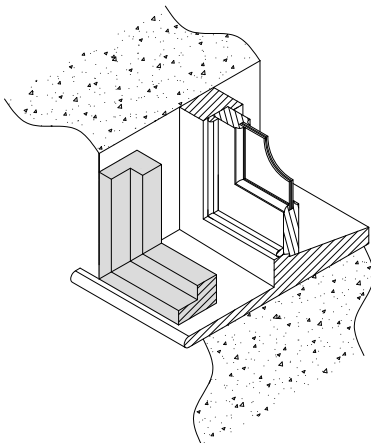

- Four sided Tick Box

4. L Frame inside reveal 3 sided

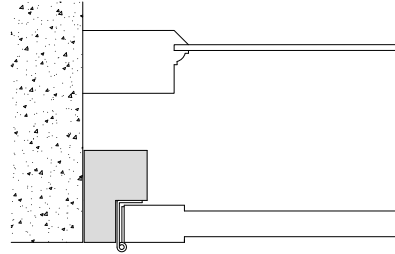
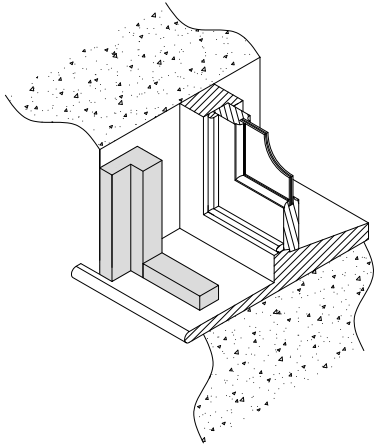

- Three sided Tick Box

5. L Frame outside reveal

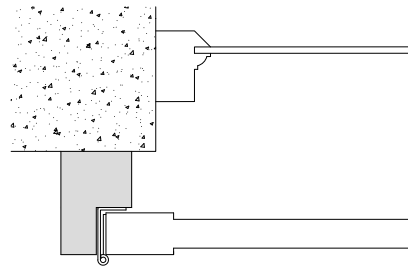
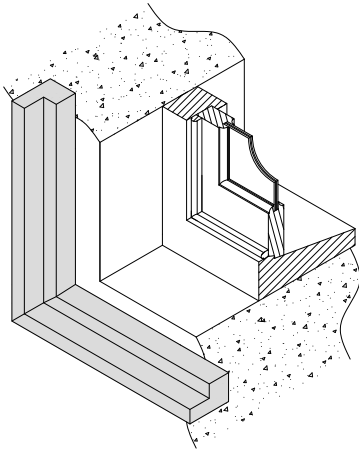

- Four sided Tick Box

6. Z Frame – 4 sided

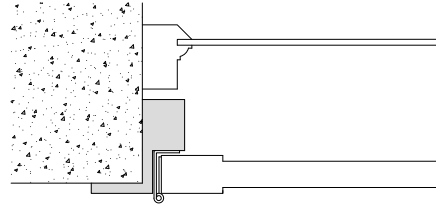
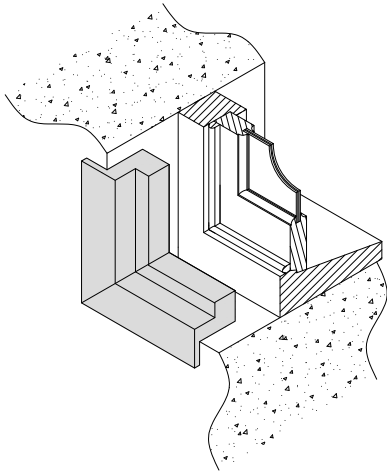

- Four sided Tick Box

7. Z Frame – 3 sided

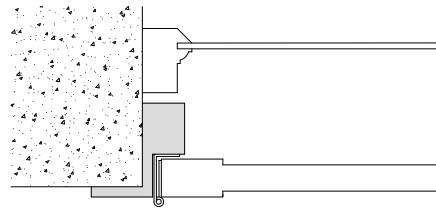
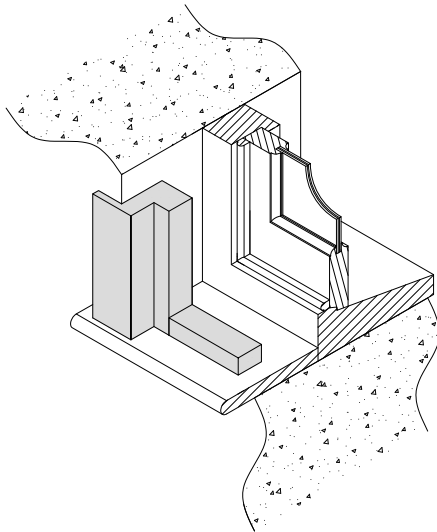

- Three sided Tick Box

Measuring Your Window

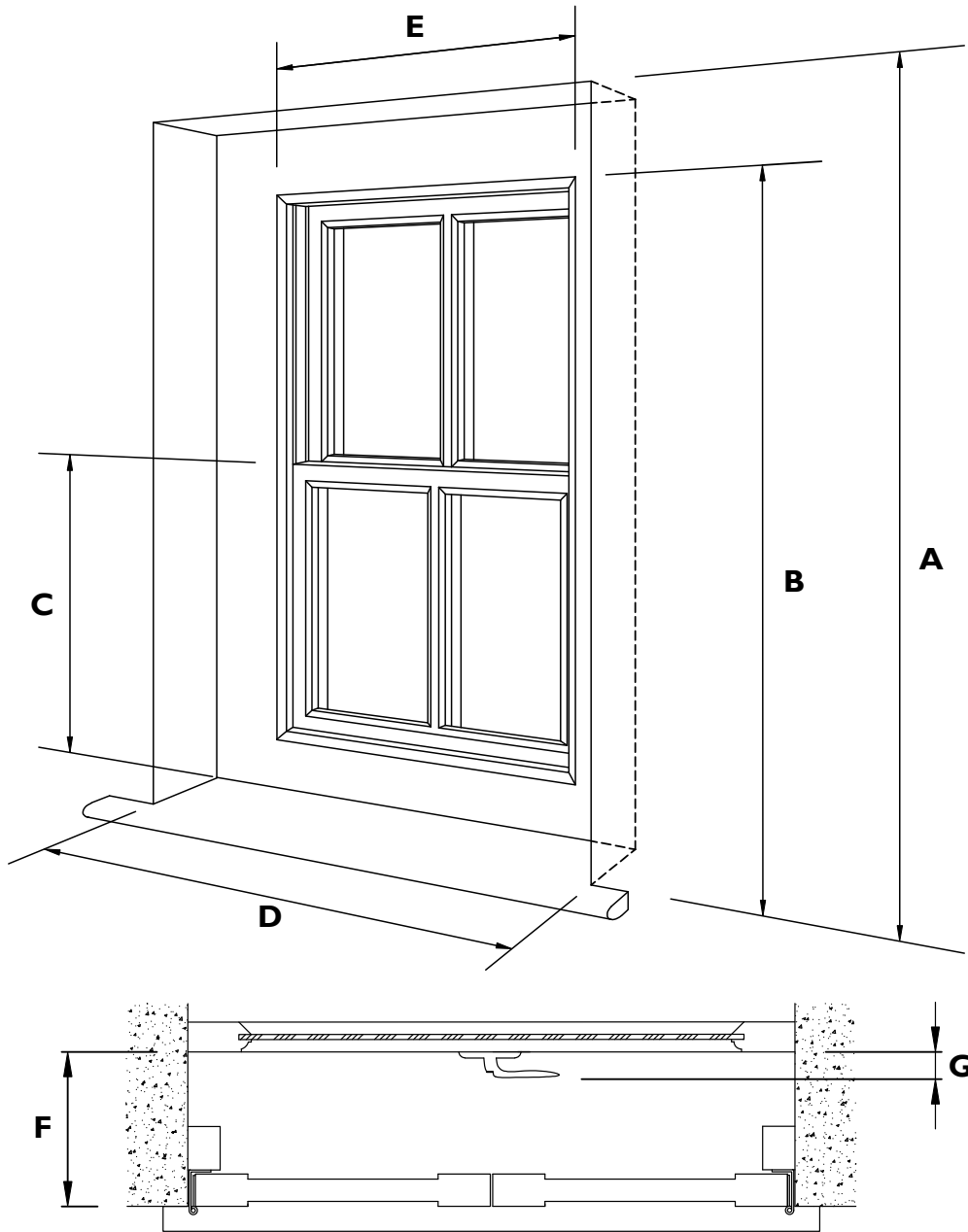

Your Window Dimensions

Letter	Description	Dimension
A	Window reveal height	
B	Height to top of window	
C	Height to window meeting rail	
D	Window reveal width	
E	Window width	
F	Window reveal depth	
G	Handle projection distance	